

## MX911-1F 802.11a/b/g/n/ac Industrial Explosion-Proof Wireless Access Point

### Features

- Explosion-proof grade: Ex d IIB T6 Gb/ExtD A21 IP68 T80℃
- Applicable industries: chemical, oil fields, coal mines, Underground Pipeline, etc.
- Supports 802.11ac standard and 2x2 MIMO
- Maximum transmission rate 867Mbps (5G) & 300Mbps (2G)
- Supports multiple application modes: access point, client, WDS access point, WDS client
- Support PPPoE and routing mode
- shaping-optimizing tech for wireless multimedia to ensure the stability for both video and transmission
- Support access to Maxon's positioning system (tag, client mode positioning)
- Support dual firmware redundant backup, maintenance operation is more secure and reliable
- Support hardware, software watchdog and wireless state synchronization mechanism to make the device run much more stable and reliable
- Support traffic shaping to ensure uniform and stable traffic of each node in the network
- Supports VLAN technology at both wired and wireless levels to make it easier to divide network segments
- Support SNMP v1/v2c/v3 network management protocol, adapt to various general network management platforms and make devices management more convenient
- Support 802.3at protocol (PoE+), the remote power supply is more convenient and reliable
- Supports web pages and AC remote operation management, making installation and maintenance more convenient
- Built-in professional lightning protection technology supports 6KV port lightning protection capability, ensures the adaptability of outdoor extreme working environment, and greatly reduces the damage rate of lightning strikes to equipment



### Description

MX911-1F Industrial Explosion-Proof Wireless Access Point is new generation 802.11ac 2x2 dual-band wireless AP device. Maxon's product can provide customers with a stable full-area outdoor wireless signal and ensure the good experience of stable, high-quality and convenient network services.

Our MX911-1F incorporates several leading core achievements to make sure stable, reliable coverage and high-throughput performance in all scenarios.

Its structure fully considers the usage in extreme industrial environments, the design meets the IP68 Protection Level rating. Combined all characteristics of explosion-proof, mildew-proof, anti-corrosion and lightning resistance. Therefore, this product can be used in almost all kinds of extreme conditions areas.



#### 25dBm high power

The highest output power can reach 25dBm, and the external omnidirectional dual-band antenna brings excellent Wi-Fi signal transmission



#### Positioning service

Support wireless probe function, docking with positioning server, which can meet the positioning requirements of smart underground pipeline and factory



#### No need to unpack design

Power supply and network access can be achieved by using product port components and connecting network cables



#### Protection Class IP68

Protection Class reaches to IP68, suitable for a variety of environments



### 2x2 MIMO

Supports 2x2 MIMO standard



### High throughput

Maximum transfer rate 1167Mbps



### Ethernet access

Supports Gigabit Ethernet/Gigabit SFP

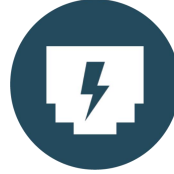

### POE powered

Supports a 100-meter Ethernet POE power supply, which is convenient for deployment and networking

## Specification

HARDWARE	shell	304 stainless steel
	Size	389*312*152mm
	net weight	14.5kg
	Installation method	Ceiling & Wall Mounting
	Protection Level	IP68
	Explosion-proof grade	Ex d IIC T6 Gb/ExtD A21 IP68 T80°C
	Antenna gain	2.4G: 6dBi; 5.8G: 8dBi
	Antenna type	Dual frequency omnidirectional antenna
	Transmission distance	0~200m
	Power supply	48V 0.5A POE
	Maximum power consumption (W)	≤18W
	Maximum transmit power	2.4G: 25dBm; 5.8G: 24dBm
	Interface (WAN)	10/100/1000Mbps
	Interface (LAN)	10/100/1000Mbps or 1000Mbps SFP (SFP optional)
	indicator	Network port indicator
	Operating temperature	-40°C~80°C
	storage temperature	-40°C~85°C
	Operating humidity	5%~95%RH non-condensing
	Surge immunity	POE/GE: Common mode 4KV, differential mode 2KV
	Electrostatic discharge immunity	Contact discharge: 6KV, air discharge: 8KV
installation kit	1 x Outer Hex Tool 2 x Dual Band Omnidirectional Antennas 1 x 48V 0.5A POE Adapter 1 x AC Power Cord 1 x Product Instruction Manual 1 x Product Certificate & Warranty Card	
SOFTWARE	work agreement	802.11a/b/g/n/ac
	Maximum speed	1167Mbps

SOFTWARE	Frequency Range	2.4G: 2412~2472MHz; 5.8G: 5180~5320MHz, 5745~5825MHz
	Channel width	20/40/80MHz
	Operating mode	Access Point, Client, WDS Access Point, WDS Client
	Security configuration	WPA2-PSK, hidden SSID, IP/MAC filtering
	application mode	AP, Client
	Configuration management	Support web configuration, support AC remote management, support SNMP management
	Ethernet Software Features	Support IPv4/IPv6 dual protocol stack DHCP Server/Client, DNS, HTTPS, IPv4, LLDP, Proxy ARP, SMTP, SNMP v2c/v3, Syslog, TCP/IP, SSH, UDP, VLAN
	Dynamic frequency selection	Support intelligent channel analysis & automatic optimal channel selection, support 5.8GHz DFS
	Smart Bandwidth Limit	Supports IP and MAC-based uplink and downlink rate limiting
	IoT expansion	Reserve UART interface to support IoT application expansion such as Bluetooth, ZigBee, UWB, etc.
	positioning service	Support wireless probe function, docking with positioning server, which can meet the positioning requirements in scenarios such as smart pipe gallery and smart factory
	other	Scheduled restart, QoS, Watchdog

## Dimensions

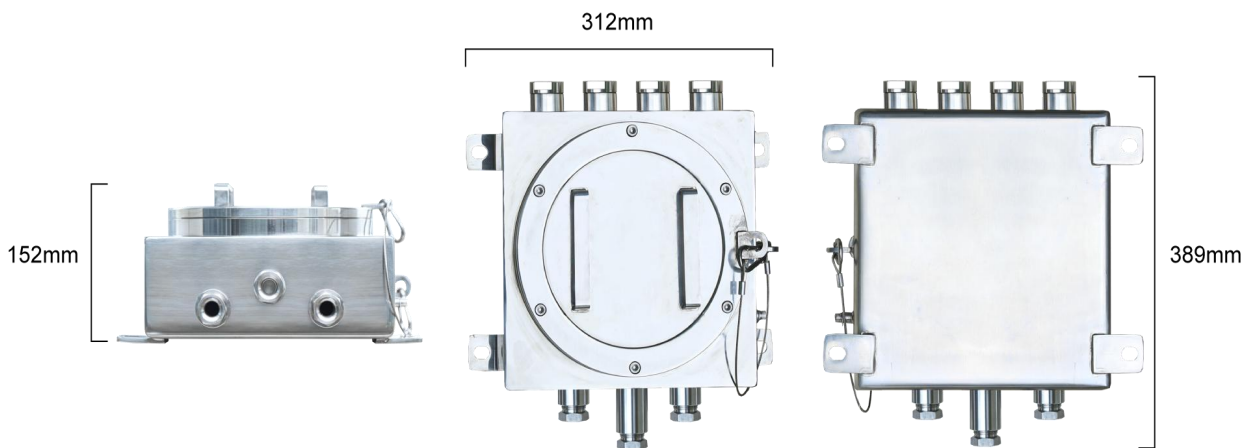

## Connector

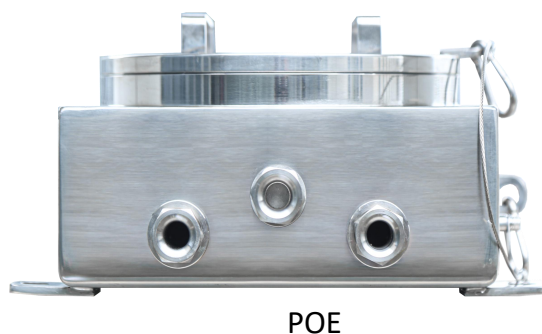

## Antenna Radiation Pattern

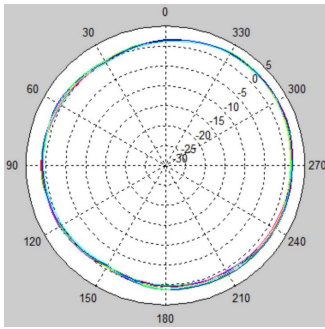

2.4G horizontal pattern

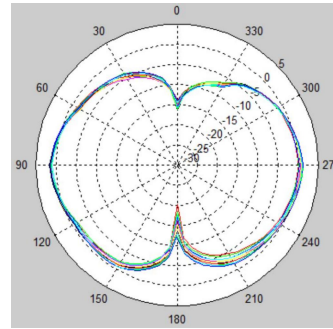

2.4G vertical pattern

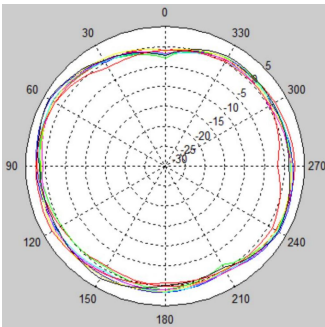

5.8G horizontal pattern

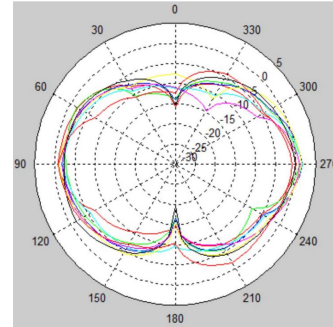

5.8G vertical pattern

## Applications

